

X Li<sup>1\*</sup>, S Caes<sup>1</sup>, T Pardoen<sup>2</sup>, G De Schutter<sup>3</sup>, B Kursten<sup>4</sup>  
<sup>1</sup>Belgian Nuclear Research Centre, Mol, Belgium  
<sup>2</sup>University of Louvain-la-Neuve, Louvain-la-Neuve, Belgium  
<sup>3</sup>Ghent University, Ghent, Belgium  
<sup>4</sup>e-mail: xli@sckcen.be

## Introduction

Al-1100 is used as the fuel cladding material to separate the inner uranium fuel and outer coolant in the Belgian Reactor 1. One feasible solution for the long-term management of BR1 fuels, which will eventually become waste, is the geological disposal in which a direct embedding of these spent fuels in a cement-based material could be used.

However, the high corrosion rate of aluminium, which is amphoteric, in the highly alkaline cementitious matrix could cause adverse effects, such as (1) the production of H<sub>2</sub> and (2) the production of expansive solid corrosion products (such as Al(OH)<sub>3</sub>). The generation of gas/solid corrosion products could increase internal stresses in the cementitious matrix and generate cracks. One possible method for inhibiting the corrosion reaction is the direct addition of an inhibition reagent to the cement matrix. Lithium nitrate, as a potential aluminum corrosion inhibitor acts through the formation of the Li-Al preservation film on the aluminum which can protect the Al surface from outer aggressive species. Therefore, the study of the inhibition effect of LiNO<sub>3</sub> on Al-1100 corrosion in Ordinary Portland Cement (OPC) matrix is valuable for studying a safe geological disposal route of the BR1 fuel.

The general objective of this study is the understanding of the mechanisms of Al corrosion in cement-based matrices and the factors that can play an important role. It can be divided into smaller aspects: (1) the evolution of the corrosion rate in OPC matrix, (2) comparison of the corrosion rate using different techniques (electrochemical and gas chromatography), (3) the influence of the addition of a corrosion inhibitor (LiNO<sub>3</sub>), and (4) the application of EIS in the study of cement porosity and its comparison with Mercury Intrusion Porosimetry (MIP) method.

## Methods

In this research, Gas Chromatography (GC) is used to measure the corrosion rate of aluminium embedded in cement matrices in anaerobic conditions. Electrochemical techniques including Electrochemical Impedance Spectroscopy (EIS), Linear Polarization Resistance (LPR) and Tafel polarization are not only applied to monitor the corrosion rate, but are also used to understand the corrosion process and the physicochemical variation of the cement matrix. Finally, microscopy (optical microscopy and SEM) are used to analyse the Al/Corrosion product film/Cement paste interface.

### ● Electrochemical cell

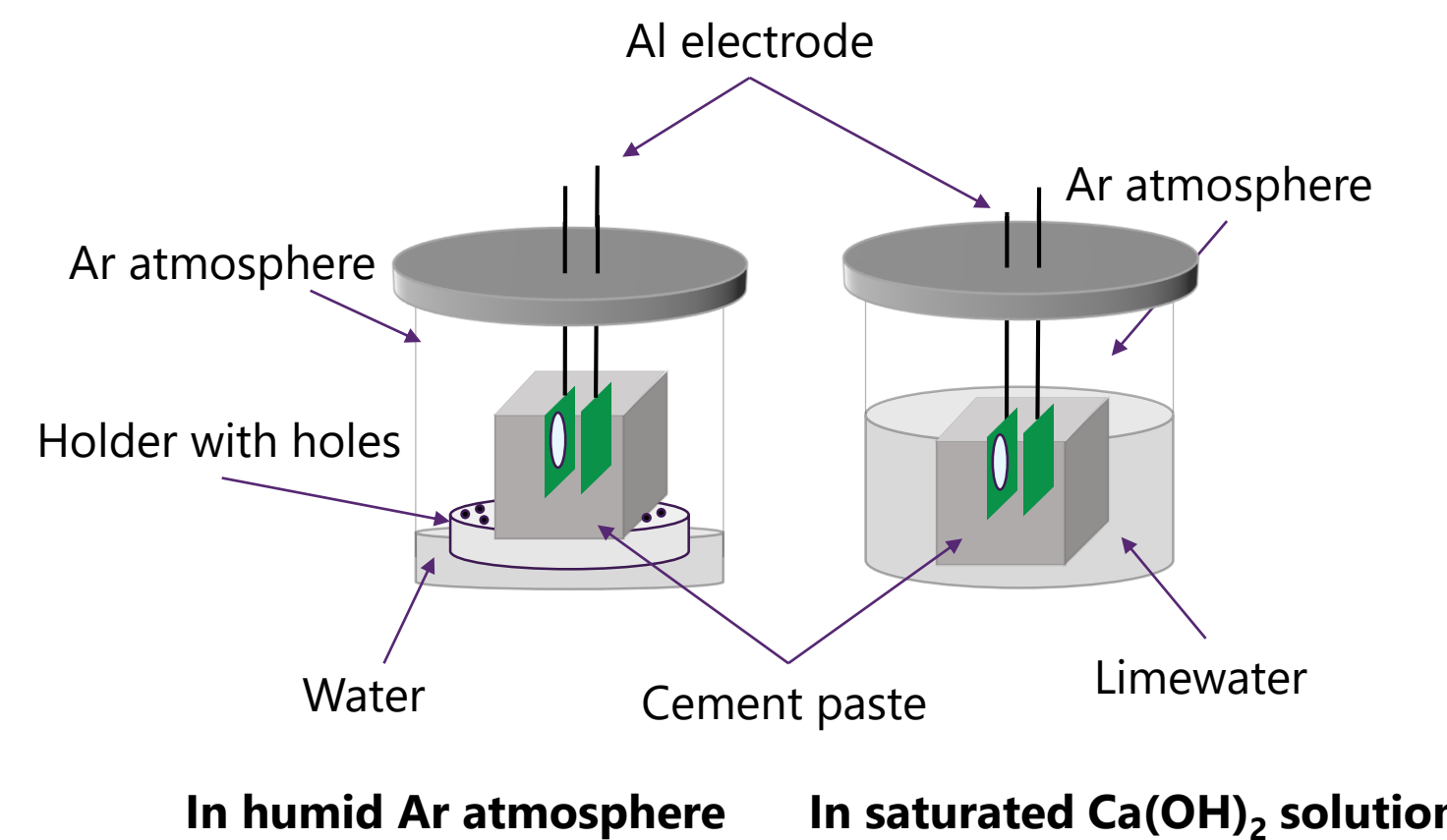

### ● Gas chromatography cell

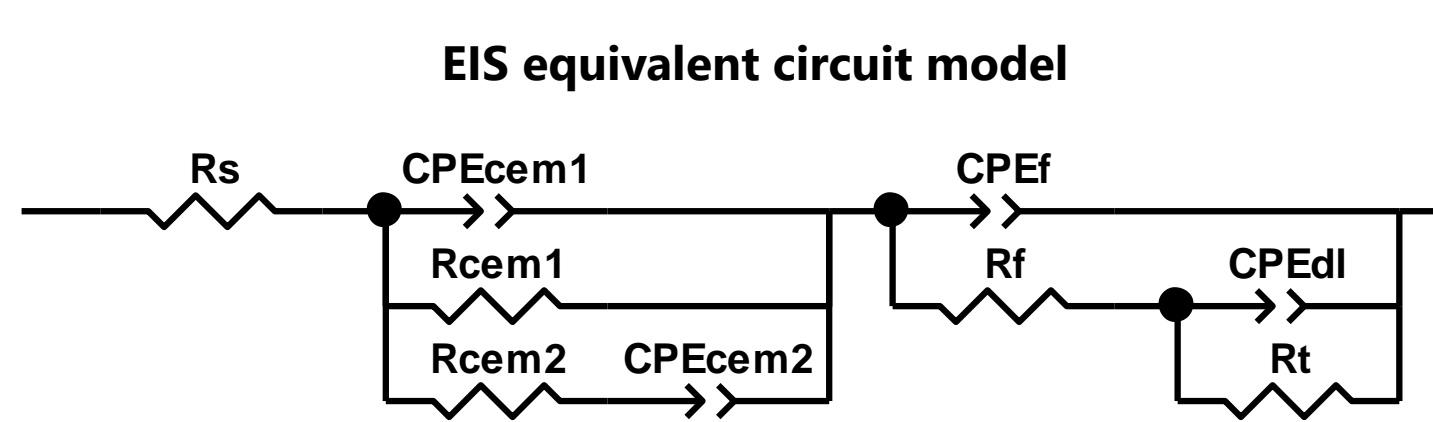
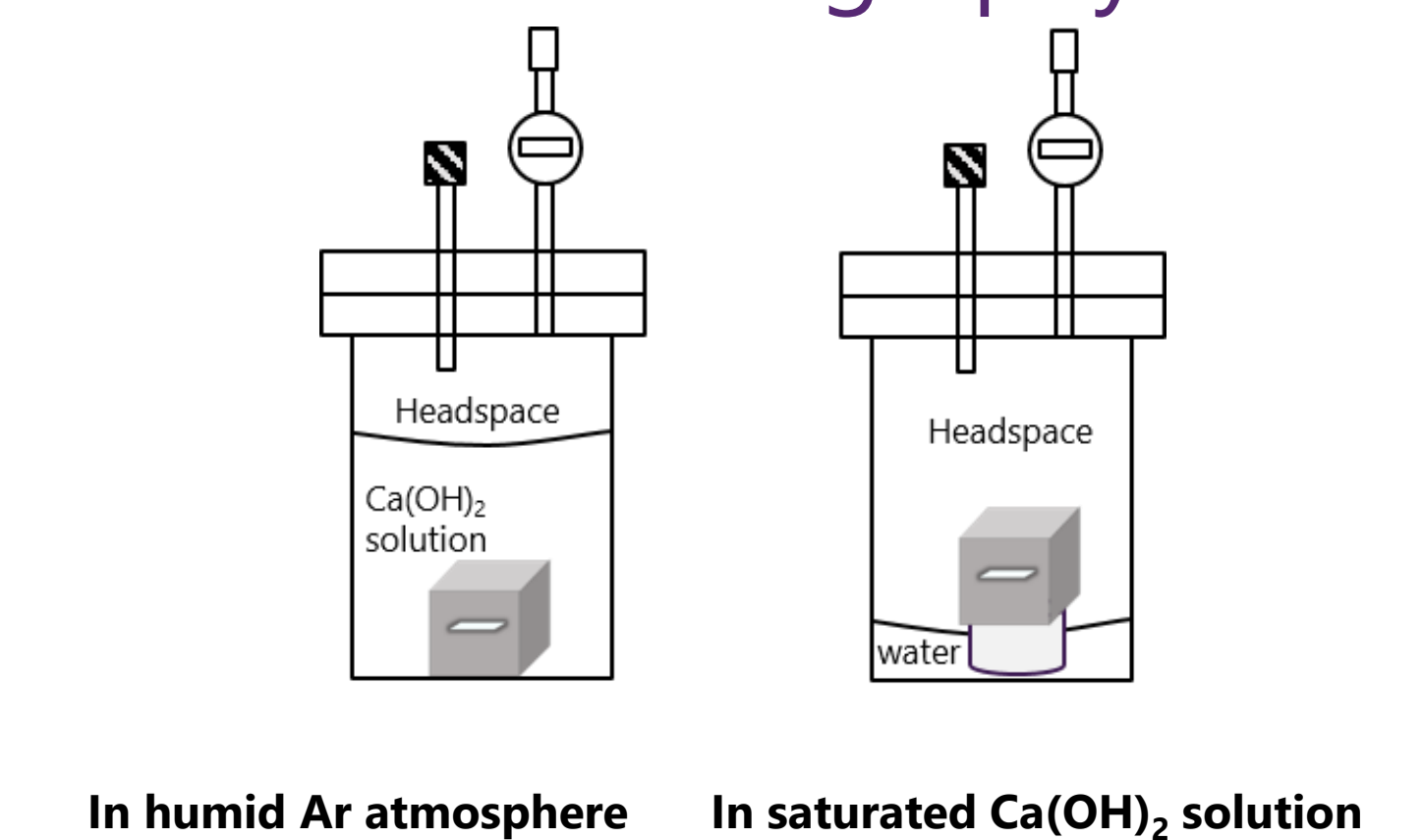

In highly alkaline condition:

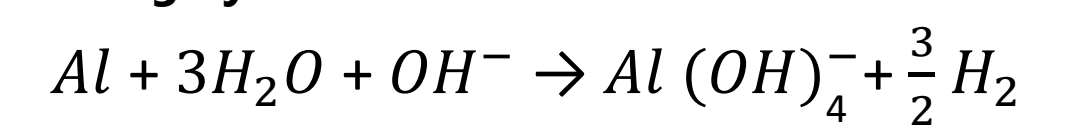

In highly alkaline condition with the presence of NO<sub>3</sub><sup>-</sup>:

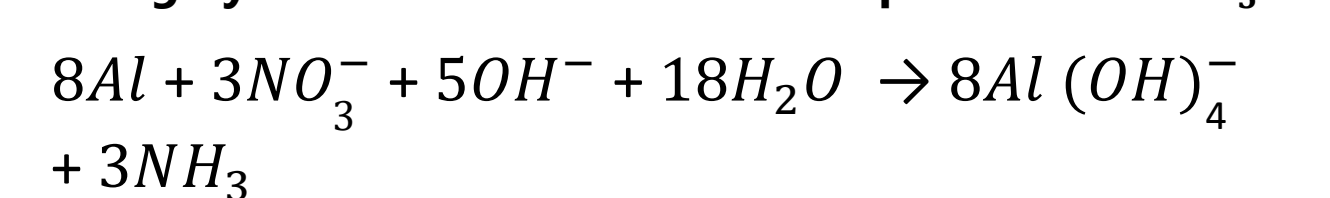

## Results

Results of Al-1100 embedded in OPC (0.36 water/cement ratio) with/without 3 wt.% LiNO<sub>3</sub> addition are given in Figures 1-3. Limewater, acting as the aggressive environment, was imposed on samples (one day after production or after 80 days in humid Ar atmosphere respectively) to roughly simulate possible underground water intrusion after breaching of the waste steel container in geological disposal. The corrosion rates are given by GC and EIS, respectively. EIS also provides the variation of the corrosion product film resistance, R<sub>f</sub>, which could be a supplement of the corrosion rate calculated from R<sub>t</sub>. Besides, EIS is capable of investigating the cement variation. Using Effective Medium Theory (EMT) and appropriate assumptions in EIS analysis, the cement porosity of samples with a water/cement ratio of 0.36 without LiNO<sub>3</sub> addition was calculated to be around 8%. The interface morphology studied by optical microscopy and SEM are illustrated in Figure 4 and 5, respectively.

Figure 1. Corrosion rates calculated from GC

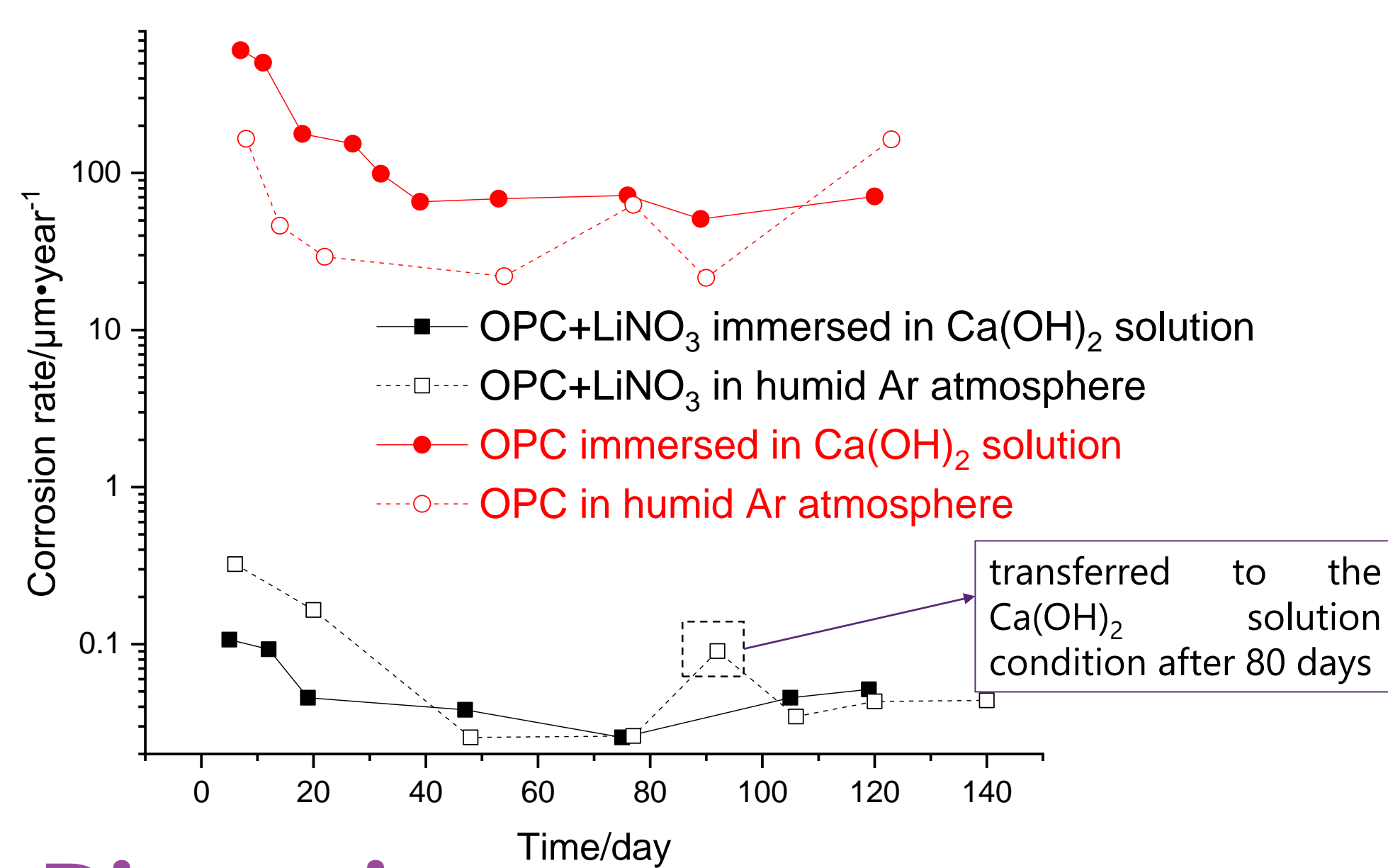

Figure 2. Corrosion rates calculated from EIS fitting

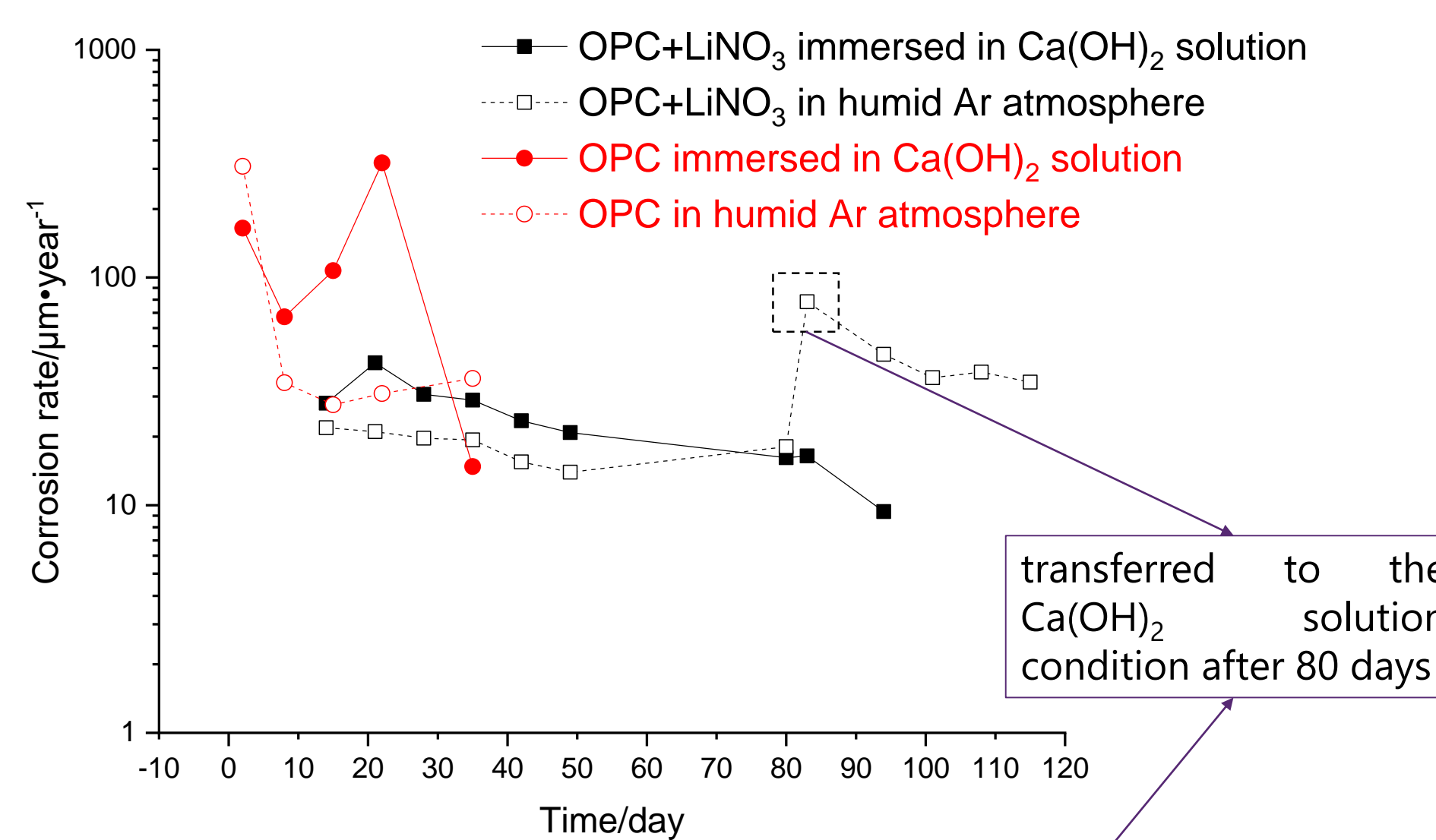

Figure 4. The interface morphology (optical microscope)

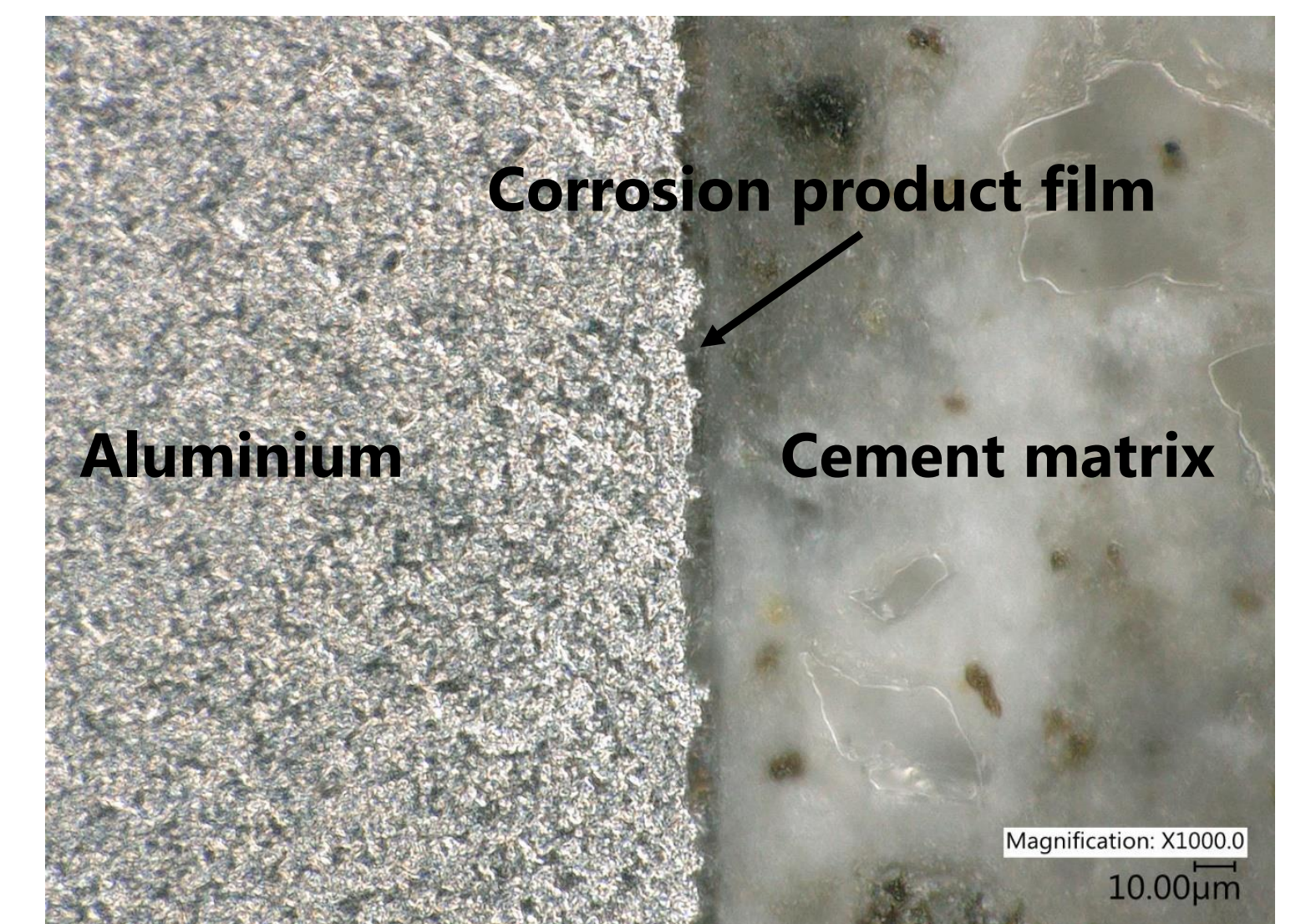
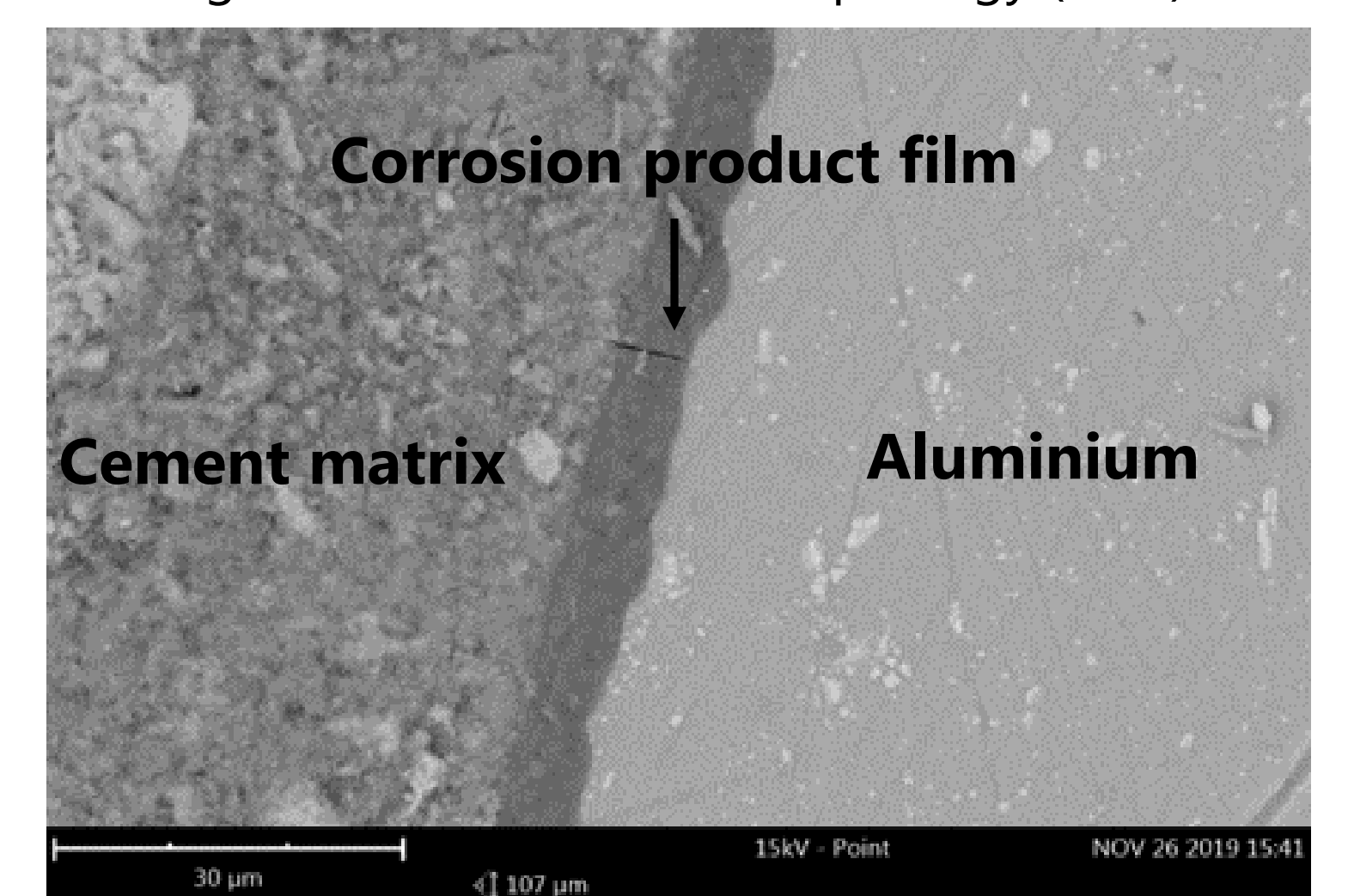

Figure 5. The interface morphology (SEM)



## Discussion

GC measurements gave abnormal corrosion rates as low as 20 nm/y comparing to around 5 µm/y from EIS results. The most likely explanation is that in the presence of nitrate, aluminium will react with nitrate ions and the main gas corrosion product should be ammonia. However, hydrogen was wrongly regarded as the main gas corrosion product leading to the mistake that the hydrogen generation amount collected from GC measurement was used to calculate the corrosion rate and hence gave abnormally low corrosion rates.

EIS fitting results proved the inverse proportional relationship between the corrosion product thickness (R<sub>f</sub>) and the corrosion rate (R<sub>t</sub>). Besides, EIS results also indicated the dissolution of the corrosion product film and a corresponding increase of the corrosion rate when samples are immersed in limewater after 80 days in humid atmosphere.

The porosity result (8%) of 0.36 w/c ratio Ordinary Portland Cement calculated from EMT is very close to that measured in the MIP test (10%). By now, the EMT model is difficult to be used for samples with LiNO<sub>3</sub>, because the LiNO<sub>3</sub> addition makes EIS fitting more complicated and raises the ion concentration in the cement bulk leading to a higher conductivity of the pore fluid, which becomes an unknown parameter in the EMT.

Figure 3. R<sub>f</sub> values obtained from EIS fitting

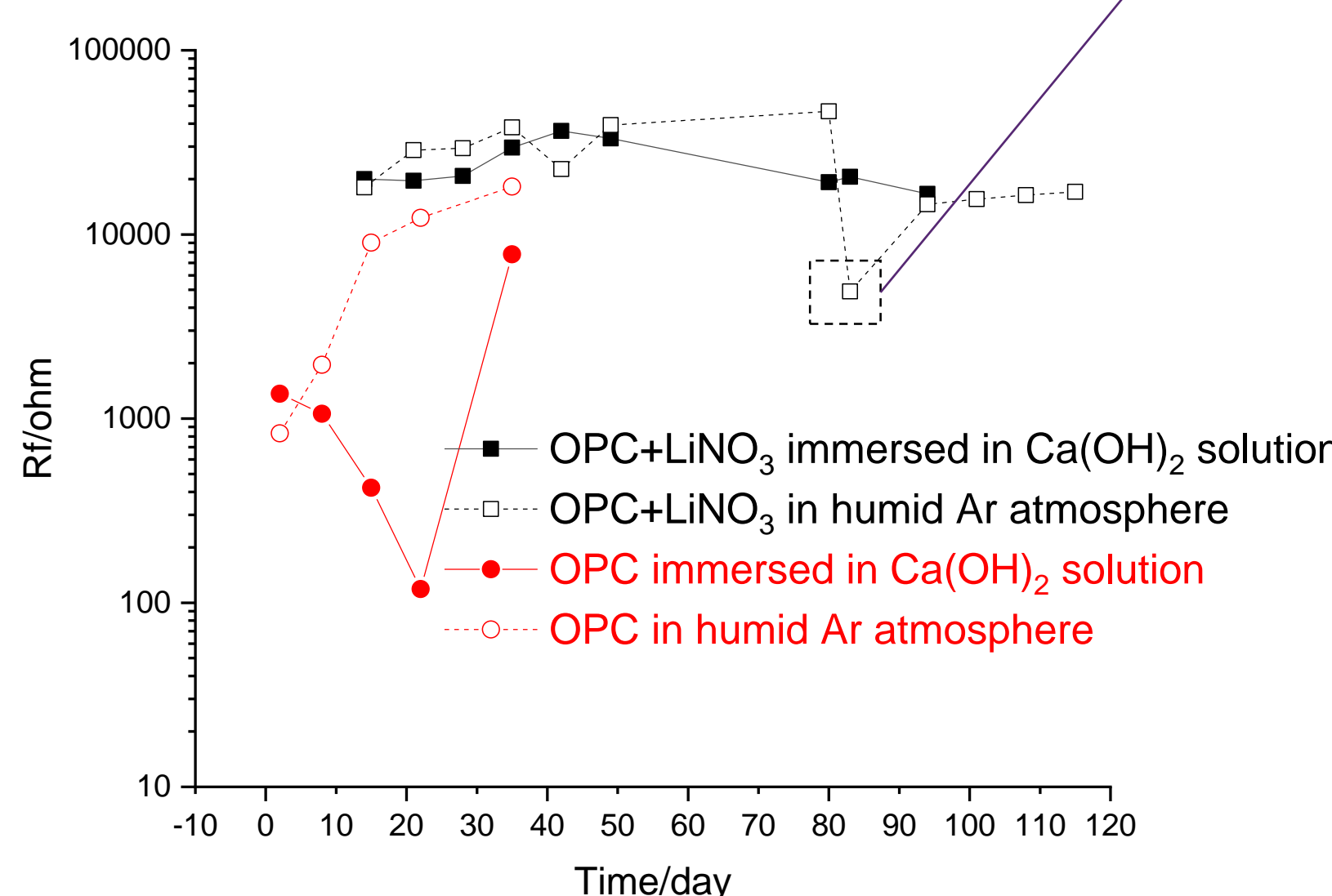

## Conclusion

The corrosion of Al in Ordinary Portland Cement and in anaerobic conditions could be effectively inhibited by the addition of lithium nitrate.

The preliminary results prove the effectiveness of lithium nitrate as a corrosion inhibitor for Al in OPC cement, although there is an obvious difference between the corrosion rates obtained with different techniques. The corrosion rate from EIS is around 5 µm/y in the steady state, while that from GC is as low as 20 nm/y. Microscopy observations proves that the EIS result is closer to the reality. Furthermore, the corrosion process is better understood. The corrosion product film plays an important role in the corrosion process and its thickness is inversely proportional to the corrosion rate. By the application of the Effective Medium Theory, the cement porosity variation could be analyzed from EIS results, which provides the influence of porosity on the corrosion process.